



HA – HIGH VOLTAGE ABC

HV Drawings Revision List

CU	DATE	REVISION	DESCRIPTION OF REVISION
	Mar 2008		Original Issue
	May 2009		See Amendment List
	Dec 2009		Revised Format
	Sept 2015		See Amendment List

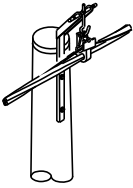
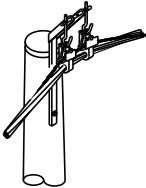
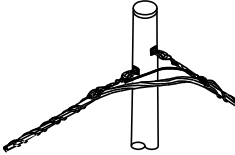
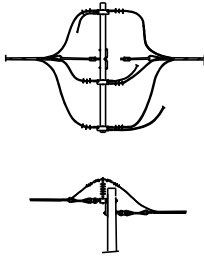
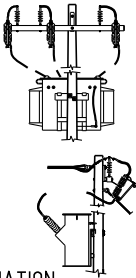
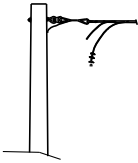
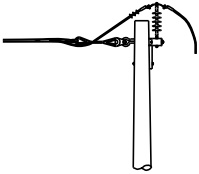
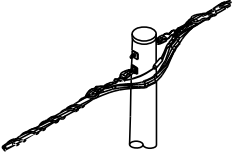
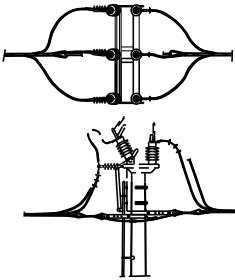
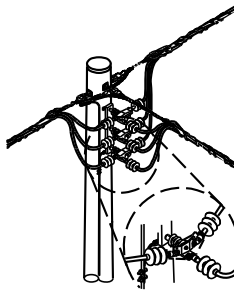
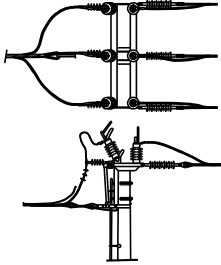
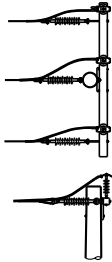

Uncontrolled document when printed. Printed copy expires one week from print date.

 <p>INTERMEDIATE 0 - 25 DEG HA1</p>	 <p>INTERMEDIATE ANGLE 26 - 44 DEG HA2</p>	 <p>STRAIN ANGLE 45 - 90 DEG HA3</p>	 <p>IN-LINE STRIAN TAP-OFF HA4</p>	
 <p>TERMINATION TRANSFORMER POLE HA5</p>	 <p>UG CABLE TERMINATION POLE HA6</p>	 <p>TERMINATION POLE HA7</p>	 <p>IN-LINE NON TENSION HA8</p>	
 <p>POLE TOP SWITCH HA9</p>	 <p>HV ABC T-OFF HA10</p>	 <p>P.T.S. HV HV TO BARE HA11</p>	 <p>BARE TERMINATION ON SURGE ARRESTERS HA12</p>	
 <p>DISTRIBUTION DESIGN CATALOGUE</p>	<p>COMPATIBLE UNITS</p>		<p>REV: B</p>	<p>DATE: 15 04 2013</p>
<p>HA COMPATIBLE UNITS</p>		<p>DRAWING No. HA INDEX-1</p>		

High Voltage Aerial Bundle Conductor, CU List

CU	CU DESCRIPTION
HA1_WI_95	HVABC Wood Pole Intermediate_95mm ²
HA1_WI_185	HVABC Wood Pole Intermediate_185mm ²
HA2_WIA_95	HVABC Wood Pole Intermediate Angle_95mm ²
HA2_WIA_185	HVABC Wood Pole Intermediate Angle_185mm ²
HA3_WSA_95	HVABC Wood pole Strain Angle_95mm ²
HA3_WSA_185	HVABC Wood Pole Strain Angle_185mm ²
HA3_CSA_95	HVABC Concrete pole Strain Angle_95mm ²
HA3_CSA_185	HVABC Concrete Pole Strain Angle_185mm ²
HA4_WST_95	HVABC Wood Pole In-line strain Tap-Off_95mm ²
HA4_WST_185	HVABC Wood Pole In-line strain Tap-Off_185mm ²
HA4_CST_95	HVABC Wood Pole In-line strain Tap-Off_95mm ²
HA4_CST_185	HVABC Concrete Pole In-line strain Tap-Off_185mm ²
HA5_WTT_95	HVABC Wood Pole Termination Transformer_95mm ²
HA5_WTT_185	HVABC Wood Pole Termination Transformer_185mm ²
HA5_CTT_95	HVABC Concrete Pole Termination Transformer_95mm ²
HA5_CTT_185	HVABC Concrete Pole Termination Transformer_185mm ²
HA6_WCT_95	HVABC Wood Pole UG Cable Termination_95mm ²
HA6_WCT_185	HVABC Wood Pole UG Cable Termination_185mm ²
HA6_CCT_95	HVABC Concrete Pole UG Cable Termination_95mm ²
HA6_CCT_185	HVABC Concrete Pole UG Cable Termination_185mm ²
HA7_WT_95	HVABC Concrete Pole Termination_95mm ²
HA7_WT_185	HVABC Wood Pole Termination_185mm ²
HA7_CT_95	HVABC Concrete Pole Termination_95mm ²
HA7_CT_185	HVABC Concrete Pole Termination_185mm ²
HA8_WIJ_95	HVABV Wood Pole Inline Joint_95mm ²
HA8_WIJ_185	HVABV Wood Pole Inline Joint_185mm ²
HA8_CIJ_95	HVABV Concrete Pole Inline Joint_95mm ²
HA8_CIJ_185	HVABV Concrete Pole Inline Joint_185mm ²
HA9_WPTS_95	HVABC Wood Pole PTS_95mm ² _22kV
HA9_WPTS185	HVABC Wood Pole PTS_185mm ² _22kV
HA9_CPTS_95	HVABC Concrete Pole PTS_95mm ² _22kV
HA9_CPTS185	HVABC Wood Pole PTS_185mm ² _22kV
HA10_WTO_95	HVABC Wood Pole Tee off_95mm ²
HA10_WTO_185	HVABC Wood Pole Tee Off_185mm ²
HA10_CTO_95	HVABC Concrete Pole Tee off_95mm ²
HA10_CTO_185	HVABC Concrete Pole Tee Off_185mm ²
HA11_WAB_95	HVABC Wood Pole PTS ABC to Bare_95mm ²
HA11_WAB_185	HVABC Wood Pole PTS ABC to Bare_185mm ²
HA11_CAB_95	HVABC Concrete Pole PTS ABC to Bare_95mm ²
HA11_CAB_185	HVABC Concrete Pole PTS ABC to Bare_185mm ²
HA12_WBT_95	HVABC Wood pole Bare termination on Surge Arresters_95mm ²
HA12_WBT_185	HVABC Wood pole Bare termination on Surge Arresters_185mm ²
HA12_CBT_95	HVABC Concrete pole Bare termination on Surge Arresters_95mm ²
HA12_CBT_185	HVABC Concrete pole Bare termination on Surge Arresters_185mm ²

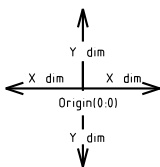
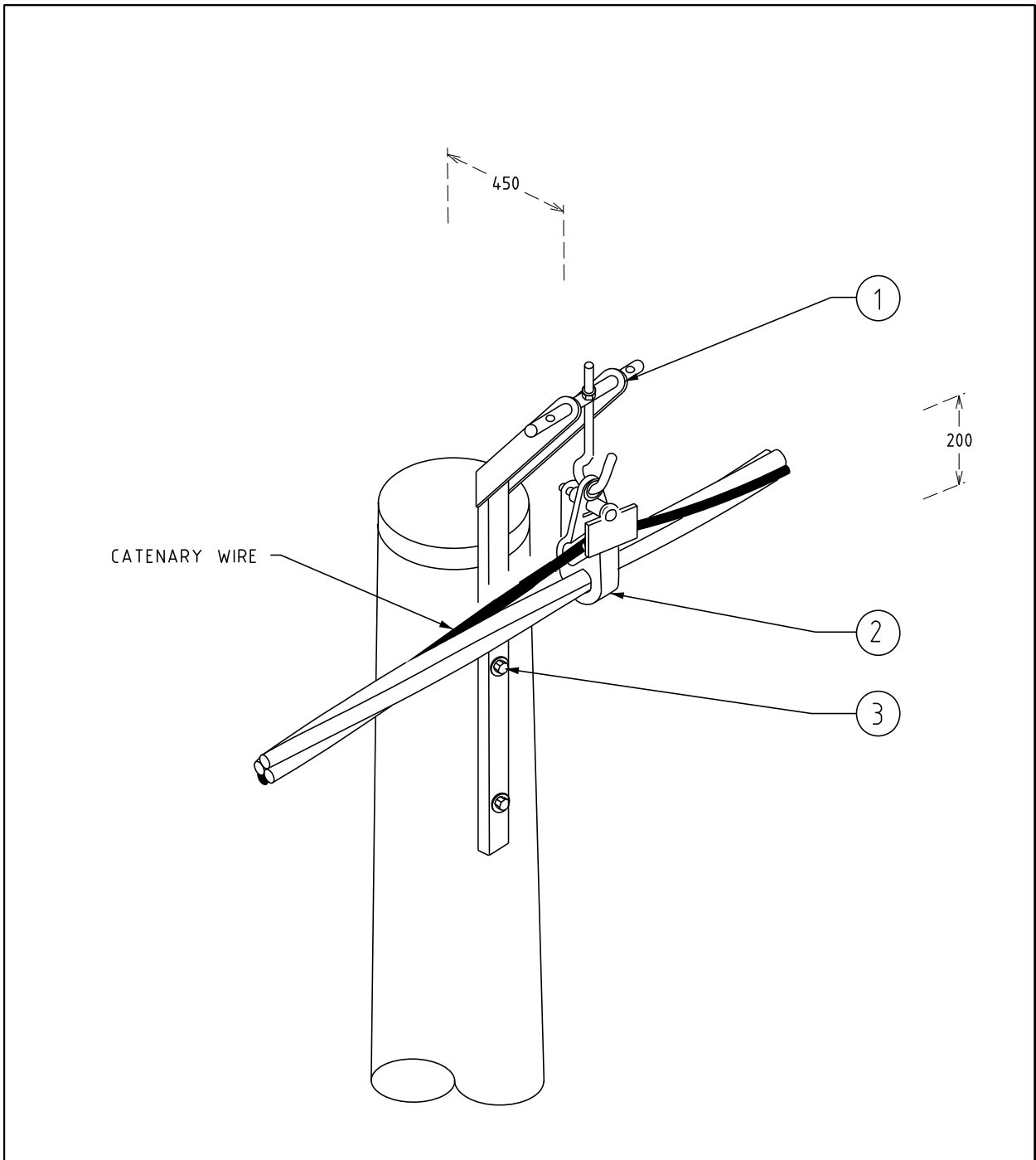

Design Dimensions	
X dim	Y dim
Catenary 450	200

Origin - Top bracket bolt (0,0)

 DISTRIBUTION DESIGN CATALOGUE	COMPATIBLE UNIT	REV. B	DATE 11.04.2013
	INTERMEDIATE 0-25° (SINGLE SUSPENSION CLAMP)	DRAWING No HA1	

CU	CU Description
----	----------------

HA1_WI_95		HVABC Wood Pole Intermediate_95mm ²			
ITEM NUMBER	STOCK CODE	DESCRIPTION	QTY RQD	UNIT OF MEASURE	REMARKS
1	CB3043	HV ABC Mtg Bracket with hookbolt	1	EA	
2	CC0643	HV ABC 95 mm ² Suspension clamp	1	EA	
3	AB6732	Pole bolt M16 x 550mm with washers	2	EA	

HA1_WI_185		HVABC Wood Pole Intermediate_185mm ²			
ITEM NUMBER	STOCK CODE	DESCRIPTION	QTY RQD	UNIT OF MEASURE	REMARKS
1	CB3043	HV ABC Mtg Bracket with hookbolt	1	EA	
2	CC0644	HV ABC 185 mm ² Suspension clamp	1	EA	
3	AB6732	Pole bolt M16 x 550mm with washers	2	EA	

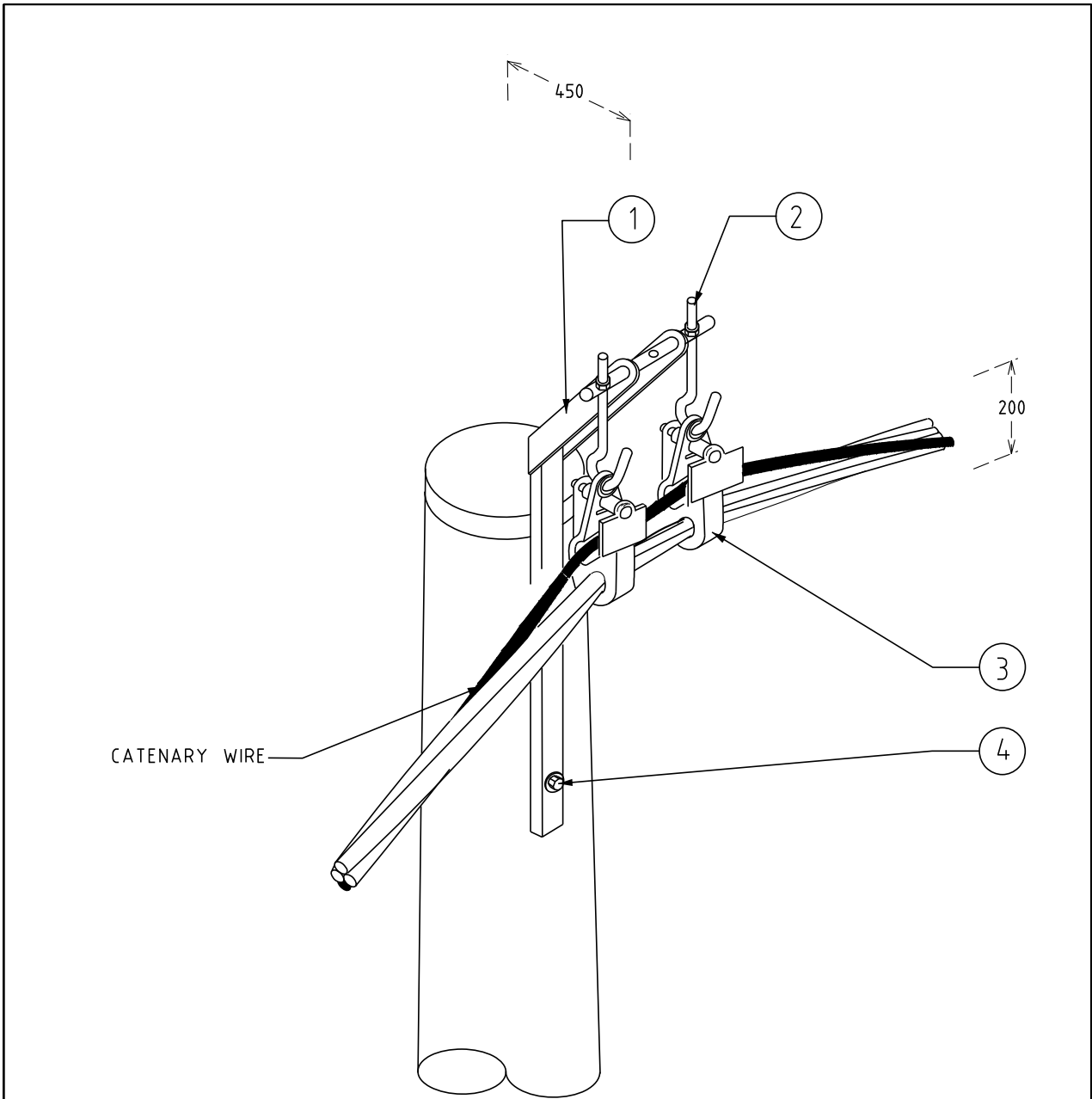

NOTE

For stay assemblies see CUs: ST1 - ST6

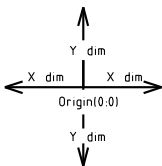

Design Dimensions

	X dim	Y dim
Catenary	450	200

Origin - Top bracket bolt (0,0)

 DISTRIBUTION DESIGN CATALOGUE	COMPATIBLE UNIT	REV B	DATE: 11 04 2013
	INTERMEDIATE ANGLE 26-44° (DOUBLE SUSPENSION CLAMP)	DRAWING No. HA2	

CU	CU Description
----	----------------

HA2_WIA_95		HVABC Wood Pole Intermediate Angle_95mm ²			
ITEM NUMBER	STOCK CODE	DESCRIPTION	QTY RQD	UNIT OF MEASURE	REMARKS
1	CB3043	HV ABC Mtg Bracket with hookbolt	1	EA	
2	AB6101	HV ABC 16mm Suspension Hookbolt	1	EA	
3	CC0643	HV ABC 95 mm ² Suspension clamp	2	EA	
4	AB6732	Pole bolt M16 x 550mm with washers	2	EA	

HA2_WIA_185		HVABC Wood Pole Intermediate Angle_185mm ²			
ITEM NUMBER	STOCK CODE	DESCRIPTION	QTY RQD	UNIT OF MEASURE	REMARKS
1	CB3043	HV ABC Mtg Bracket with hookbolt	1	EA	
2	AB6101	HV ABC 16mm Suspension Hookbolt	1	EA	
3	CC0644	HV ABC 185 mm ² Suspension clamp	2	EA	
4	AB6732	Pole bolt M16 x 550mm with washers	2	EA	

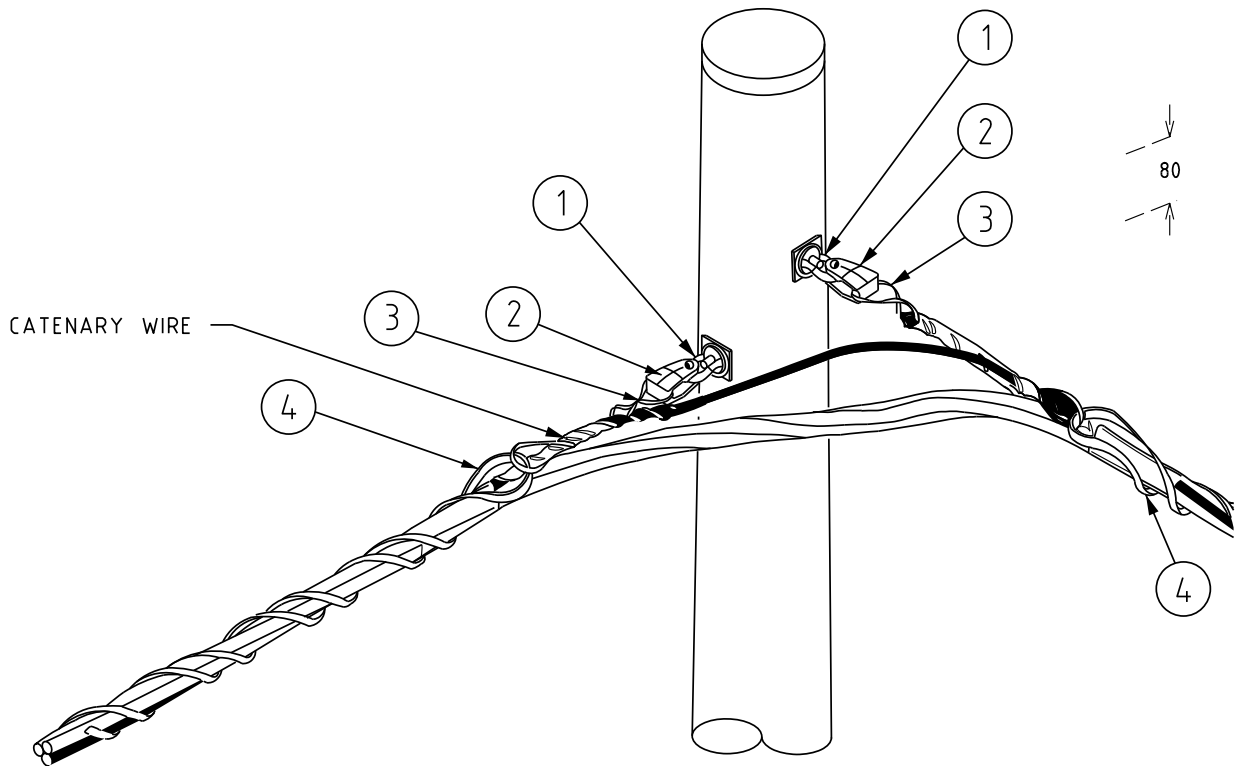

NOTE

For stay assemblies see CUs: ST1 - ST6

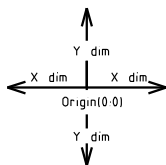

Design Dimensions

Catenary	X dim	Y dim
LHS	0	80
RHS	0	0

Origin - Top eye bolt (0,0)

 DISTRIBUTION DESIGN CATALOGUE	COMPATIBLE UNIT	REV B	DATE 12 04 2013
	STRAIN ANGLE 45-90°	DRAWING No HA3	

CU	CU Description
----	----------------

HA3_WSA_95		HVABC Wood pole Strain Angle_95mm ²			
ITEM NUMBER	STOCK CODE	DESCRIPTION	QTY RQD	UNIT OF MEASURE	REMARKS
1	AB6025	Eyebolt M16 x 450mm with Washers	2	EA	
2	CT0011	Clevis Thimble, Cond. 7/2.50-19/3.25	2	EA	
3	CF0757	Deadend Grip, Helically Cond. 7/4.75	2	EA	
4	CF0585	HVABC Anti bird caging Grip, 95mm ²	2	EA	

HA3_WSA_185		HVABC Wood Pole Strain Angle_185mm ²			
ITEM NUMBER	STOCK CODE	DESCRIPTION	QTY RQD	UNIT OF MEASURE	REMARKS
1	AB6025	Eyebolt M16 x 450mm with Washers	2	EA	
2	CT0011	Clevis Thimble, Cond. 7/2.50-19/3.25	2	EA	
3	CF0580	Deadend Grip, Helically Cond. 19/3.65	2	EA	
4	CF0586	HVABC Anti bird caging Grip, 185mm ²	2	EA	

HA3_CSA_95		HVABC Concrete pole Strain Angle_95mm ²			
ITEM NUMBER	STOCK CODE	DESCRIPTION	QTY RQD	UNIT OF MEASURE	REMARKS
	CB3060	Metal Retaining Strap 50mm x 1.3m	2	EA	
1	CT0011	Clevis Thimble, Cond. 7/2.50-19/3.25	2	EA	
2	CF0757	Deadend Grip, Helically Cond. 7/4.75	2	EA	
3	CF0585	HVABC Anti bird caging Grip, 95mm ²	2	EA	

HA3_CSA_185		HVABC Concrete Pole Strain Angle_185mm ²			
ITEM NUMBER	STOCK CODE	DESCRIPTION	QTY RQD	UNIT OF MEASURE	REMARKS
1	CB3060	Metal Retaining Strap 50mm x 1.3m	2	EA	
2	CT0011	Clevis Thimble, Cond. 7/2.50-19/3.25	2	EA	
3	CF0580	Deadend Grip, Helically Cond. 19/3.65	2	EA	
4	CF0586	HVABC Anti bird caging Grip, 185mm ²	2	EA	

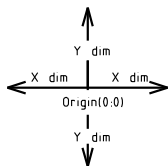
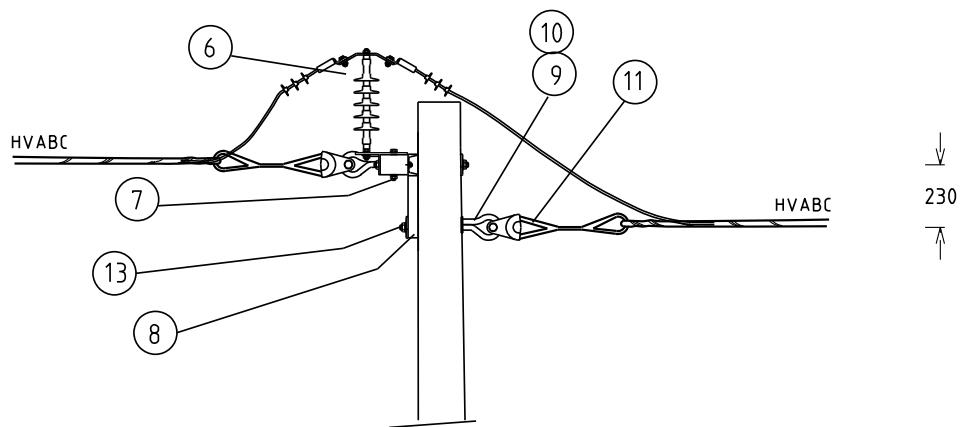
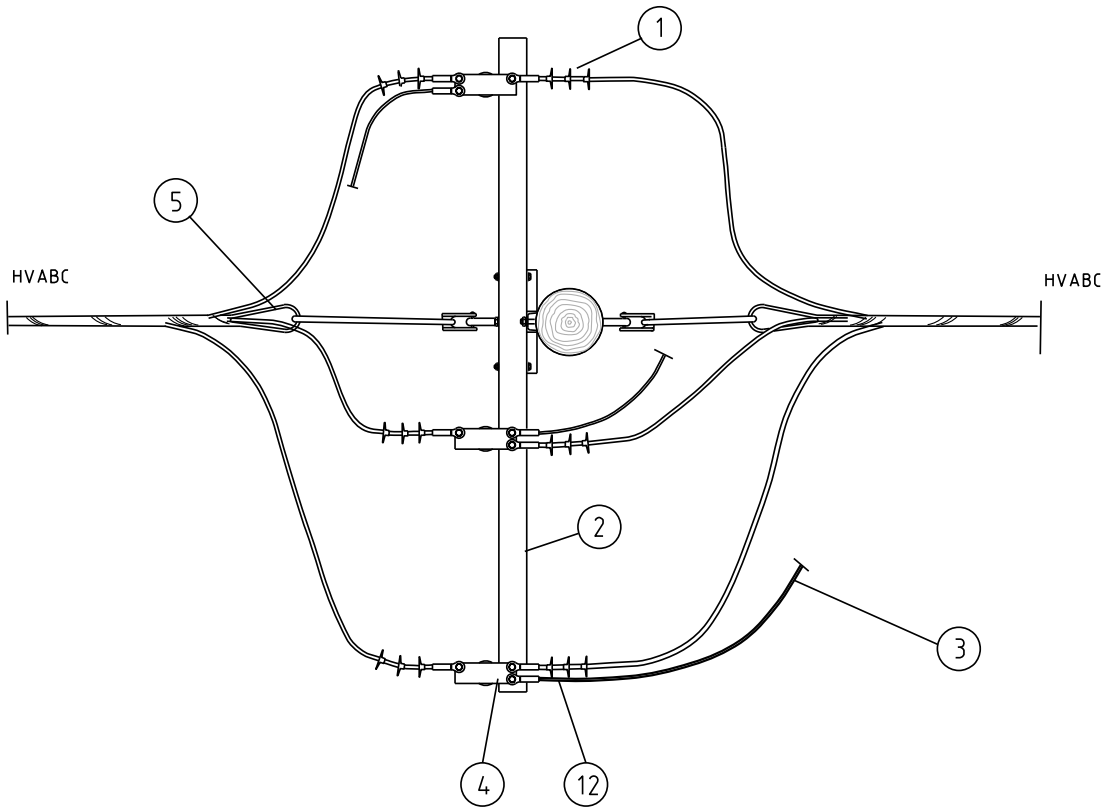

NOTE

For stay assemblies see CUs ST1 - ST6
 For earthing assembly see CU: HV34

Design Dimensions

Catenary	X dim	Y dim
LHS	0	0
RHS	0	230

Origin - Cross arm king bolt (0:0)



DISTRIBUTION DESIGN
 CATALOGUE

COMPATIBLE UNIT

IN-LINE STRAIN
 18 TAP OFF

REV.

B

DATE:

12.04.2013

DRAWING No

HA4



CU	CU Description
----	----------------

HA4_WST_95		HVABC Wood Pole In-line Strain Tap-Off_95mm ²			
ITEM NUMBER	STOCK CODE	DESCRIPTION	QTY ROD	UNIT OF MEASURE	REMARKS
1	FJ0189	HVABC Term Kit 95-185mm ² 3x1 Core	2	EA	
2	CB1121	Crossarm,Metal 2.4m Long	1	EA	
3	FT0150	LV ABC Leads, 4x4m Long, 150mm ²	1	EA	
4	GF1591	Copper Bus Conductor plate	3	EA	
5	CF0585	HVABC Anti bird caging Grip, 95mm ²	2	EA	
6	GA4002	Surge Arrester 22kV, 10kA	3	EA	
7	CZ0366	Crossarm Bolt 130mm Long Steel,Galv	3	EA	
8	CB3025	HV Crossarm T-Bracket	1	EA	
9	AB6025	Eyebolt M16 x 450mm with Washers	2	EA	
10	CT0011	Clevis Thimble, Cond. 7/2.50-19/3.25	2	EA	
11	CF0757	Deadend Grip, Helically Cond. 7/4.75	2	EA	
12	FL1476	Eye Lug, 150mm ² , M12 Hole, Cu Tinned	3	EA	

HA4_WST_185		HVABC Wood Pole In-line strain Tap-Off_185mm ²			
ITEM NUMBER	STOCK CODE	DESCRIPTION	QTY ROD	UNIT OF MEASURE	REMARKS
1	FJ0189	HVABC Term Kit 95-185mm ² 3x1 Core	2	EA	
2	CB1121	Crossarm,Metal 2.4m Long	1	EA	
3	FT0150	LV ABC Leads, 4x4m Long, 150mm ²	1	EA	
4	GF1591	Copper Bus Conductor plate	3	EA	
5	CF0586	HVABC Anti bird caging Grip, 185mm ²	2	EA	
6	GA4002	Surge Arrester 22kV, 10kA	3	EA	
7	CZ0366	Crossarm Bolt 130mm Long Steel,Galv	3	EA	
8	CB3025	HV Crossarm T-Bracket	1	EA	
9	AB6025	Eyebolt M16 x 450mm with Washers	2	EA	
10	CT0011	Clevis Thimble, Cond. 7/2.50-19/3.25	2	EA	
11	CF0580	Deadend Grip, Helically Cond. 19/3.65	2	EA	
12	FL1476	Eye Lug, 150mm ² , M12 Hole, Cu Tinned	3	EA	

CU	CU Description
----	----------------

HA4_CST_95		HVABC Concrete Pole In-line Strain Tap-Off_95mm ²			
ITEM NUMBER	STOCK CODE	DESCRIPTION	QTY ROD	UNIT OF MEASURE	REMARKS
1	FJ0189	HVABC Term Kit 95-185mm ² 3x1 Core	2	EA	
2	CB1121	Crossarm,Metal 2.4m Long	1	EA	
3	FT0150	LV ABC Leads, 4x4m Long, 150mm ²	1	EA	
4	GF1591	Copper Bus Conductor plate	3	EA	
5	CF0585	HVABC Anti bird caging Grip, 95mm ²	2	EA	
6	GA4002	Surge Arrester 22kV, 10kA	3	EA	
7	CZ0366	Crossarm Bolt 130mm Long Steel,Galv	3	EA	
8	CB3051	Crossarm Mtg Bracket, Concrete Pole	2	EA	
9	CB3060	Metal Retaining Strap 50mm x 1.3m	2	EA	
10	CT0011	Clevis Thimble, Cond. 7/2.50-19/3.25	2	EA	
11	CF0757	Deadend Grip, Helically Cond. 7/4.75	2	EA	
12	FL1476	Eye Lug, 150mm ² , M12 Hole, Cu Tinned	3	EA	
13	CB7541	U-Bolt Concrete Pole strap, M16	2	EA	

HA4_CST_185		HVABC Concrete Pole In-Line Strain Tap-Off_185mm ²			
ITEM NUMBER	STOCK CODE	DESCRIPTION	QTY ROD	UNIT OF MEASURE	REMARKS
1	FJ0189	HVABC Term Kit 95-185mm ² 3x1 Core	2	EA	
2	CB1121	Crossarm,Metal 2.4m Long	1	EA	
3	FT0150	LV ABC Leads, 4x4m Long, 150mm ²	1	EA	
4	GF1591	Copper Bus Conductor plate	3	EA	
5	CF0586	HVABC Anti bird caging Grip, 185mm ²	2	EA	
6	GA4002	Surge Arrester 22kV, 10kA	3	EA	
7	CZ0366	Crossarm Bolt 130mm Long Steel,Galv	3	EA	
8	CB3051	Crossarm Mtg Bracket, Concrete Pole	2	EA	
9	CB3060	Metal Retaining Strap 50mm x 1.3m	2	EA	
10	CT0011	Clevis Thimble, Cond. 7/2.50-19/3.25	2	EA	
11	CF0580	Deadend Grip, Helically Cond. 19/3.65	2	EA	
12	FL1476	Eye Lug, 150mm ² , M12 Hole, Cu Tinned	3	EA	
13	CB7541	U-Bolt Concrete Pole strap, M16	2	EA	

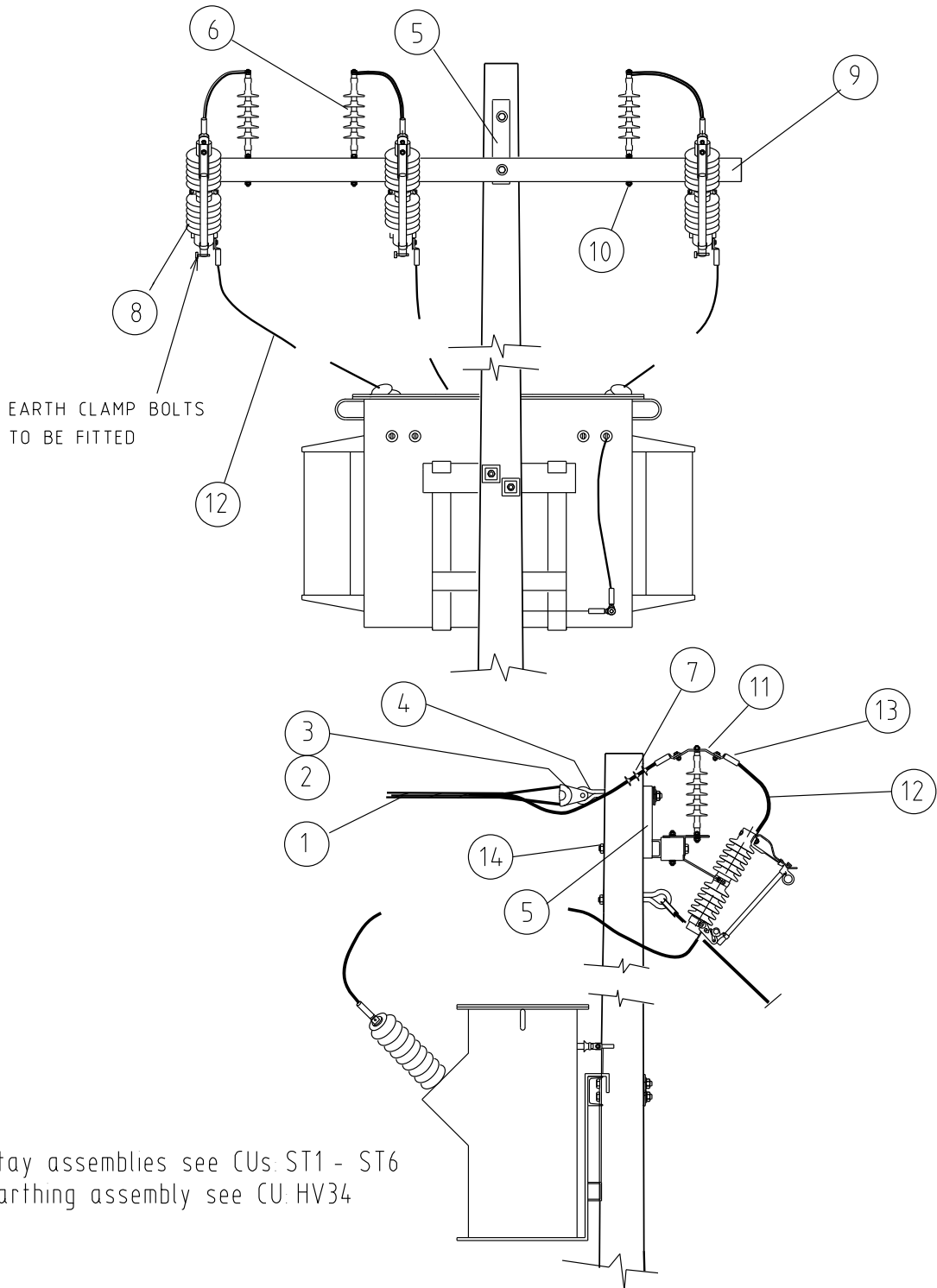

 DISTRIBUTION DESIGN CATALOGUE	COMPATIBLE UNIT	REV B	DATE 15 04 2013
	TERMINATION TRANSFORMER POLE	DRAWING No HA5	

CU	CU Description
----	----------------

HA5_WTT_95		HVABC Wood Pole Termination Transformer_95mm ²			
ITEM NUMBER	STOCK CODE	DESCRIPTION	QTY ROD	UNIT OF MEASURE	REMARKS
1	CF0585	HVABC Anti bird caging Grip, 95mm ²	1	EA	
2	CT0011	Clevis Thimble, Cond. 7/2.50-19/3.25	1	EA	
3	CF0757	Deadend Grip, Helically Cond. 7/4.75	1	EA	
4	AB6025	Eyebolt M16 x 450mm with Washers	1	EA	
5	CB3025	HV Crossarm T-Bracket	1	EA	
6	GA4002	Surge Arrester 22kV, 10kA	3	EA	
7	FJ0189	HVABC Term Kit 95-185mm ² 3x1 Core	1	EA	
8	GF1850	Drop out fuse 11,22 & 33kV	3	EA	
9	CB1121	Crossarm,Metal 2.4m Long	1	EA	
10	CZ0366	Crossarm Bolt 130mm Long Steel,Galv	3	EA	
11	GF1591	Copper Bus Conductor plate	3	EA	
12	FT0150	LV ABC Leads, 4x4m Long, 150mm ²	1	EA	
13	FL1476	Eye Lug, 150mm ² , M12 Hole, Cu Tinned	3	EA	
14	AB6732	Pole bolt M16 x 550mm with washers	1	EA	

HA5_WTT_185		HVABC Wood Pole Termination Transformer_185mm ²			
ITEM NUMBER	STOCK CODE	DESCRIPTION	QTY ROD	UNIT OF MEASURE	REMARKS
1	CF0586	HVABC Anti bird caging Grip, 185mm ²	1	EA	
2	CT0011	Clevis Thimble, Cond. 7/2.50-19/3.25	1	EA	
3	CF0580	Deadend Grip, Helically Cond. 19/3.65	1	EA	
4	AB6025	Eyebolt M16 x 450mm with Washers	1	EA	
5	CB3025	HV Crossarm T-Bracket	1	EA	
6	GA4002	Surge Arrester 22kV, 10kA	3	EA	
7	FJ0189	HVABC Term Kit 95-185mm ² 3x1 Core	1	EA	
8	GF1850	Drop out fuse 11,22 & 33kV	3	EA	
9	CB1121	Crossarm,Metal 2.4m Long	1	EA	
10	CZ0366	Crossarm Bolt 130mm Long Steel,Galv	3	EA	
11	GF1591	Copper Bus Conductor plate	3	EA	
12	FT0150	LV ABC Leads, 4x4m Long, 150mm ²	1	EA	
13	FL1476	Eye Lug, 150mm ² , M12 Hole, Cu Tinned	3	EA	
14	AB6732	Pole bolt M16 x 550mm with washers	1	EA	

CU		CU Description			
HA5_CTT_95		HVABC Concrete Pole Termination Transformer_95mm ²			
ITEM NUMBER	STOCK CODE	DESCRIPTION	QTY ROD	UNIT OF MEASURE	REMARKS
1	CF0585	HVABC Anti bird caging Grip, 95mm ²	1	EA	
2	CT0011	Clevis Thimble, Cond. 7/2.50-19/3.25	1	EA	
3	CF0757	Deadend Grip, Helically Cond. 7/4.75	1	EA	
4	CB3060	Metal Retaining Strap 50mm x 1.3m	1	EA	
5	CB3051	Crossarm Mtg Bracket, Concrete Pole	1	EA	
6	GA4002	Surge Arrester 22kV, 10kA	3	EA	
7	FJ0189	HVABC Term Kit 95-185mm ² 3x1 Core	1	EA	
8	GF1850	Drop out fuse 11,22 & 33kV	3	EA	
9	CB1121	Crossarm,Metal 2.4m Long	1	EA	
10	CZ0366	Crossarm Bolt 130mm Long Steel,Galv	3	EA	
11	GF1591	Copper Bus Conductor plate	3	EA	
12	FT0150	LV ABC Leads, 4x4m Long, 150mm ²	1	EA	
13	FL1476	Eye Lug, 150mm ² , M12 Hole, Cu Tinned	3	EA	
14	CB7541	U-Bolt Concrete Pole strap, M16	2	EA	

HA5_CTT_185		HVABC Concrete Pole Termination Transformer_185mm ²			
ITEM NUMBER	STOCK CODE	DESCRIPTION	QTY ROD	UNIT OF MEASURE	REMARKS
1	CF0586	HVABC Anti bird caging Grip, 185mm ²	1	EA	
2	CT0011	Clevis Thimble, Cond. 7/2.50-19/3.25	1	EA	
3	CF0580	Deadend Grip, Helically Cond. 19/3.65	1	EA	
4	CB3060	Metal Retaining Strap 50mm x 1.3m	1	EA	
5	CB3051	Crossarm Mtg Bracket, Concrete Pole	1	EA	
6	GA4002	Surge Arrester 22kV, 10kA	3	EA	
7	FJ0189	HVABC Term Kit 95-185mm ² 3x1 Core	1	EA	
8	GF1850	Drop out fuse 11,22 & 33kV	3	EA	
9	CB1121	Crossarm,Metal 2.4m Long	1	EA	
10	CZ0366	Crossarm Bolt 130mm Long Steel,Galv	3	EA	
11	GF1591	Copper Bus Conductor plate	3	EA	
12	FT0150	LV ABC Leads, 4x4m Long, 150mm ²	1	EA	
13	FL1476	Eye Lug, 150mm ² , M12 Hole, Cu Tinned	3	EA	
14	CB7541	U-Bolt Concrete Pole strap, M16	2	EA	

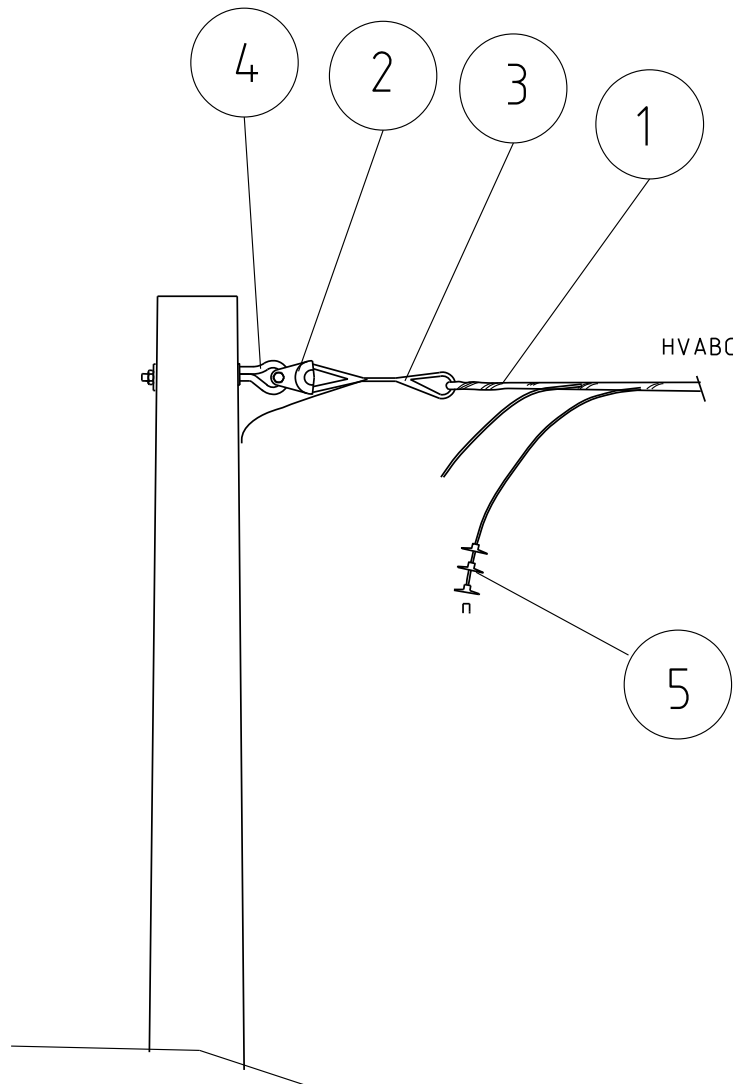

NOTE:

For stay assemblies see CUs: ST1 - ST6
 For cable termination and earthing assemblies see CUs: HU17 - HU21

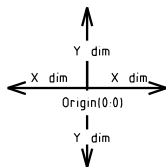

Design Dimensions

	X dim	Y dim
Catenary	0	0

Origin - Eye bolt (0-0)

 DISTRIBUTION DESIGN CATALOGUE	COMPATIBLE UNIT	REV B	DATE 12 04 2013
	UG CABLE TERMINATION POLE	DRAWING No HA6	

CU	CU Description
----	----------------

HA6_WCT_95		HVABC Wood Pole UG Cable Termination_95mm ²			
ITEM NUMBER	STOCK CODE	DESCRIPTION	QTY RQD	UNIT OF MEASURE	REMARKS
1	CF0585	HVABC Anti bird caging Grip, 95mm ²	1	EA	
2	CT0011	Clevis Thimble, Cond. 7/2.50-19/3.25	1	EA	
3	CF0757	Deadend Grip, Helically Cond. 7/4.75	1	EA	
4	AB6025	Eyebolt M16 x 450mm with Washers	1	EA	
5	FJ0189	HVABC Term Kit 95-185mm ² 3x1 Core	1	EA	

HA6_WCT_185		HVABC Wood Pole UG Cable Termination_185mm ²			
ITEM NUMBER	STOCK CODE	DESCRIPTION	QTY RQD	UNIT OF MEASURE	REMARKS
1	CF0586	HVABC Anti bird caging Grip, 185mm ²	1	EA	
2	CT0011	Clevis Thimble, Cond. 7/2.50-19/3.25	1	EA	
3	CF0580	Deadend Grip, Helically Cond. 19/3.65	1	EA	
4	AB6025	Eyebolt M16 x 450mm with Washers	1	EA	
5	FJ0189	HVABC Term Kit 95-185mm ² 3x1 Core	1	EA	

HA6_CCT_95		HVABC Concrete Pole UG Cable Termination_95mm ²			
ITEM NUMBER	STOCK CODE	DESCRIPTION	QTY RQD	UNIT OF MEASURE	REMARKS
1	CF0585	HVABC Anti bird caging Grip, 95mm ²	1	EA	
2	CT0011	Clevis Thimble, Cond. 7/2.50-19/3.25	1	EA	
3	CF0757	Deadend Grip, Helically Cond. 7/4.75	1	EA	
4	CB3060	Metal Retaining Strap 50mm x 1.3m	1	EA	
5	FJ0189	HVABC Term Kit 95-185mm ² 3x1 Core	1	EA	

HA6_CCT_185		HVABC Concrete Pole UG Cable Termination_185mm ²			
ITEM NUMBER	STOCK CODE	DESCRIPTION	QTY RQD	UNIT OF MEASURE	REMARKS
1	CF0586	HVABC Anti bird caging Grip, 185mm ²	1	EA	
2	CT0011	Clevis Thimble, Cond. 7/2.50-19/3.25	1	EA	
3	CF0580	Deadend Grip, Helically Cond. 19/3.65	1	EA	
4	CB3060	Metal Retaining Strap 50mm x 1.3m	1	EA	
5	FJ0189	HVABC Term Kit 95-185mm ² 3x1 Core	1	EA	

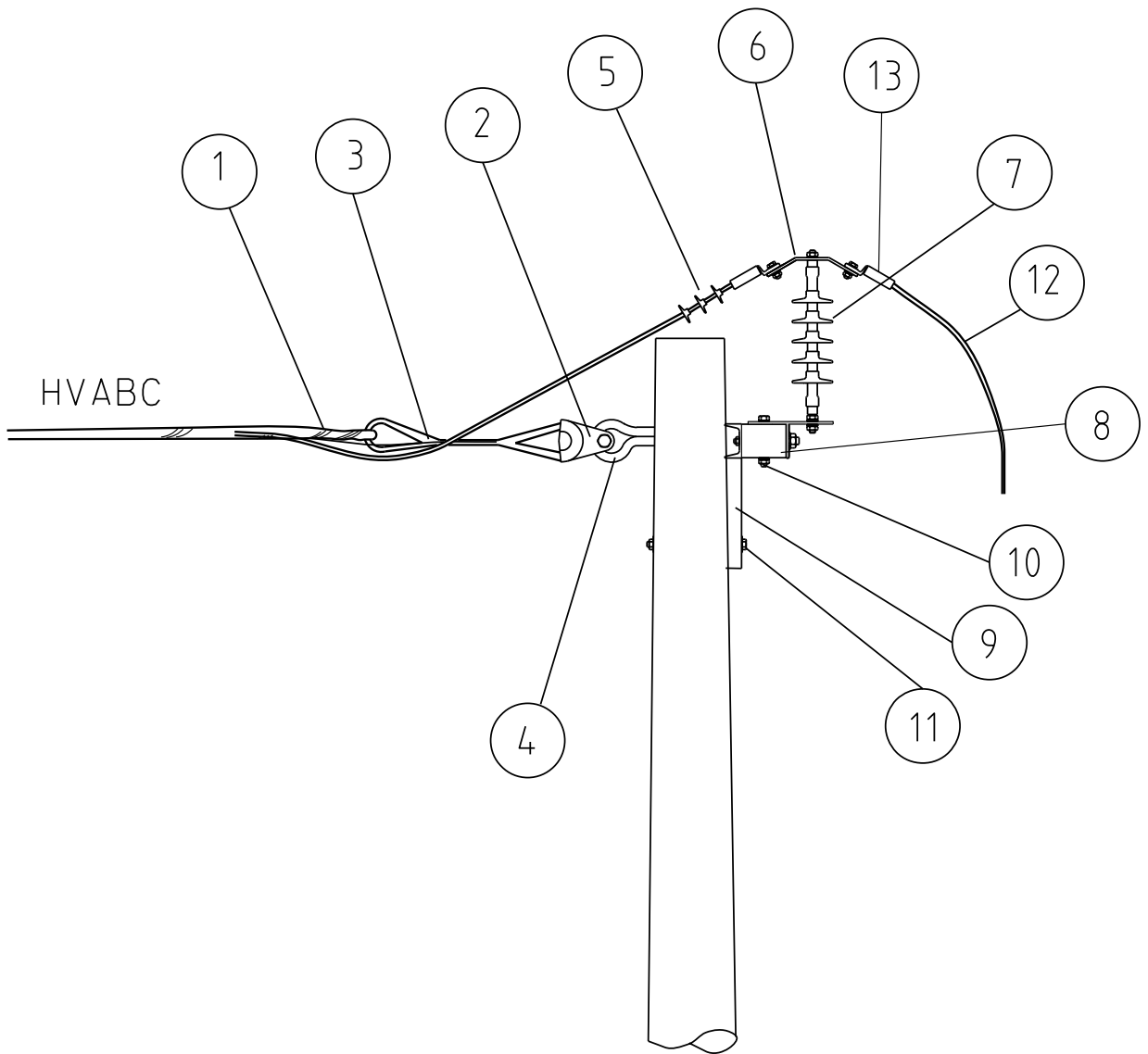

NOTE:

For stay assemblies see CU: ST1 - ST6
 For earthing assembly see CU: HV34

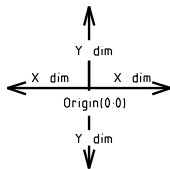

Design Dimensions

	X dim	Y dim
Catenary	0	0

Origin - Cross arm eye bolt (0-0)

 DISTRIBUTION DESIGN CATALOGUE	COMPATIBLE UNIT	REV. B	DATE: 12 04 2013
	HVABC TERNINATION POLE	DRAWING No. HA7	

CU		CU Description			
HA7_WT_95		HVABC Wood Pole Termination_95mm ²			
ITEM NUMBER	STOCK CODE	DESCRIPTION	QTY ROD	UNIT OF MEASURE	REMARKS
1	CF0585	HVABC Anti bird caging Grip, 95mm ²	1	EA	
2	CT0011	Clevis Thimble, Cond. 7/2.50-19/3.25	1	EA	
3	CF0757	Deadend Grip, Helically Cond. 7/4.75	1	EA	
4	AB6025	Eyebolt M16 x 450mm with Washers	1	EA	
5	FJ0189	HVABC Term Kit 95-185mm ² 3x1 Core	1	EA	
6	GF1591	Copper Bus Conductor plate	3	EA	
7	GA4002	Surge Arrester 22kV, 10kA	3	EA	
8	CB1121	Crossarm,Metal 2.4m Long	1	EA	
9	CB3025	HV Crossarm T-Bracket	1	EA	
10	CZ0366	Crossarm Bolt 130mm Long Steel,Galv	3	EA	
11	AB6732	Pole bolt M16 x 550mm with washers	1	EA	
12	FT0150	LV ABC Leads, 4x4m Long, 150mm ²	1	EA	
13	FL1476	Eye Lug, 150mm ² , M12 Hole, Cu Tinned	3	EA	

HA7_WT_185		HVABC Wood Pole Termination_185mm ²			
ITEM NUMBER	STOCK CODE	DESCRIPTION	QTY ROD	UNIT OF MEASURE	REMARKS
1	CF0586	HVABC Anti bird caging Grip, 185mm ²	1	EA	
2	CT0011	Clevis Thimble, Cond. 7/2.50-19/3.25	1	EA	
3	CF0580	Deadend Grip, Helically Cond. 19/3.65	1	EA	
4	AB6025	Eyebolt M16 x 450mm with Washers	1	EA	
5	FJ0189	HVABC Term Kit 95-185mm ² 3x1 Core	1	EA	
6	GF1591	Copper Bus Conductor plate	3	EA	
7	GA4002	Surge Arrester 22kV, 10kA	3	EA	
8	CB1121	Crossarm,Metal 2.4m Long	1	EA	
9	CB3025	HV Crossarm T-Bracket	1	EA	
10	CZ0366	Crossarm Bolt 130mm Long Steel,Galv	3	EA	
11	AB6732	Pole bolt M16 x 550mm with washers	1	EA	
12	FT0150	LV ABC Leads, 4x4m Long, 150mm ²	1	EA	
13	FL1476	Eye Lug, 150mm ² , M12 Hole, Cu Tinned	3	EA	

CU		CU Description			
HA7_CT_95		HVABC Concrete Pole Termination_95mm ²			
ITEM NUMBER	STOCK CODE	DESCRIPTION	QTY ROD	UNIT OF MEASURE	REMARKS
1	CF0585	HVABC Anti bird caging Grip, 95mm ²	1	EA	
2	CT0011	Clevis Thimble, Cond. 7/2.50-19/3.25	1	EA	
3	CF0757	Deadend Grip, Helically Cond. 7/4.75	1	EA	
4	CB3060	Metal Retaining Strap 50mm x 1.3m	1	EA	
5	FJ0189	HVABC Term Kit 95-185mm ² 3x1 Core	1	EA	
6	GF1591	Copper Bus Conductor plate	3	EA	
7	GA4002	Surge Arrester 22kV, 10kA	3	EA	
8	CB1121	Crossarm, Metal 2.4m Long	1	EA	
9	CB3051	Crossarm Mtg Bracket, Concrete Pole	1	EA	
10	CZ0366	Crossarm Bolt 130mm Long Steel, Galv	3	EA	
11	CB7541	U-Bolt Concrete Pole strap, M16	2	EA	
12	FT0150	LV ABC Leads, 4x4m Long, 150mm ²	1	EA	
13	FL1476	Eye Lug, 150mm ² , M12 Hole, Cu Tinned	3	EA	

HA7_CT_185		HVABC Concrete Pole Termination_185mm ²			
ITEM NUMBER	STOCK CODE	DESCRIPTION	QTY ROD	UNIT OF MEASURE	REMARKS
1	CF0586	HVABC Anti bird caging Grip, 185mm ²	1	EA	
2	CT0011	Clevis Thimble, Cond. 7/2.50-19/3.25	1	EA	
3	CF0580	Deadend Grip, Helically Cond. 19/3.65	1	EA	
4	CB3060	Metal Retaining Strap 50mm x 1.3m	1	EA	
5	FJ0189	HVABC Term Kit 95-185mm ² 3x1 Core	1	EA	
6	GF1591	Copper Bus Conductor plate	3	EA	
7	GA4002	Surge Arrester 22kV, 10kA	3	EA	
8	CB1121	Crossarm, Metal 2.4m Long	1	EA	
9	CB3051	Crossarm Mtg Bracket, Concrete Pole	1	EA	
10	CZ0366	Crossarm Bolt 130mm Long Steel, Galv	3	EA	
11	CB7541	U-Bolt Concrete Pole strap, M16	2	EA	
12	FT0150	LV ABC Leads, 4x4m Long, 150mm ²	1	EA	
13	FL1476	Eye Lug, 150mm ² , M12 Hole, Cu Tinned	3	EA	

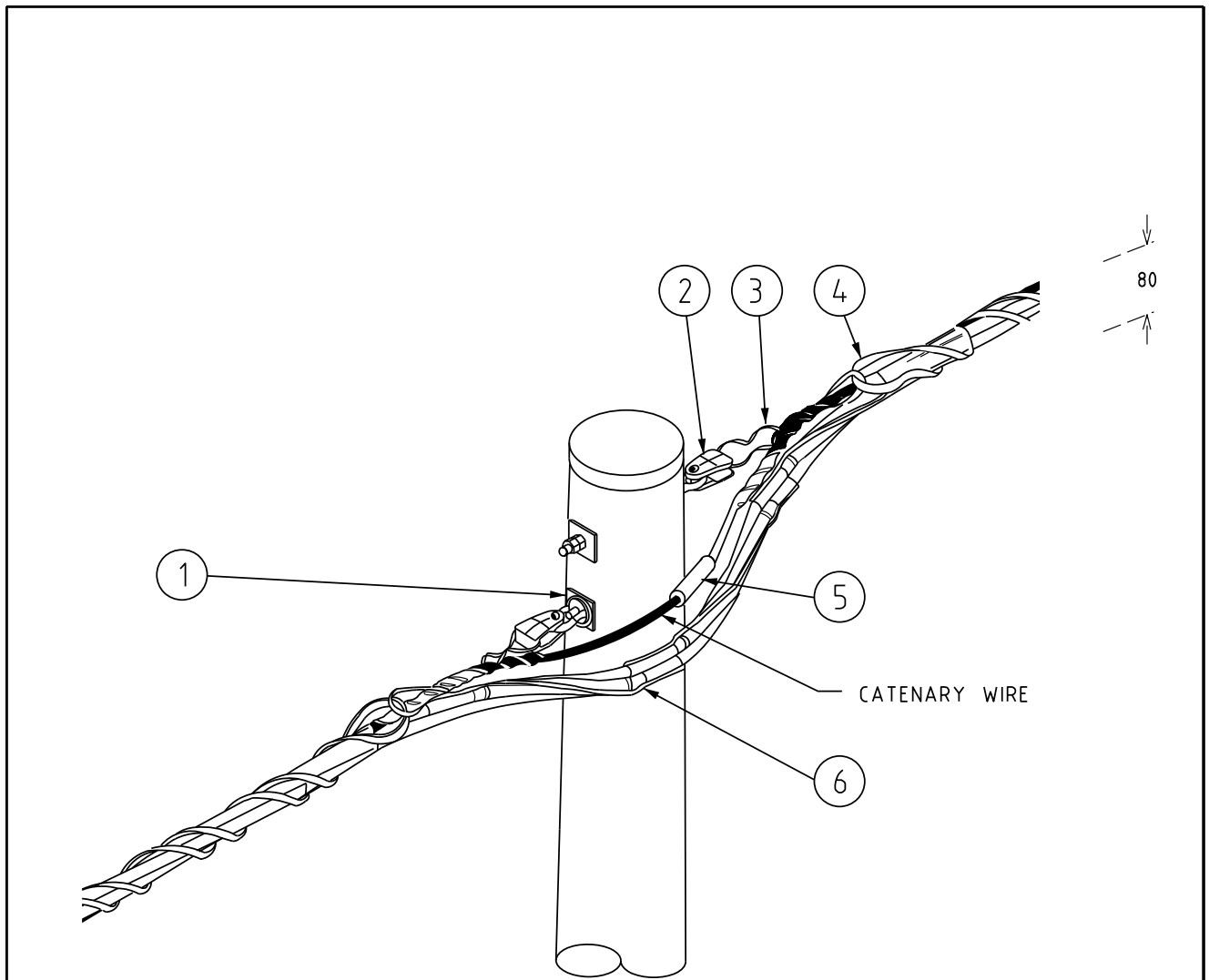

NOTE:

For stay assemblies see CUs ST1 - ST6

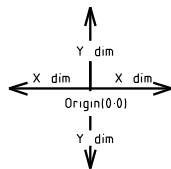

Design Dimensions

Catenary	X dim	Y dim
LHS	0	80
RHS	0	0

Origin - Top eye bolt (0-0)

 DISTRIBUTION DESIGN CATALOGUE	COMPATIBLE UNIT	REV. B	DATE: 12 04 2013
	INLINE NON-TENSION JOINT 45-90°	DRAWING No. HA8	

CU	CU Description
----	----------------

HA8_WIJ_95		HVABV Wood Pole Inline Joint_95mm ²			
ITEM NUMBER	STOCK CODE	DESCRIPTION	QTY ROD	UNIT OF MEASURE	REMARKS
1	AB6025	Eyebolt M16 x 450mm with Washers	2	EA	
2	CT0011	Clevis Thimble, Cond. 7/2.50-19/3.25	2	EA	
3	CF0757	Deadend Grip, Helically Cond. 7/4.75	2	EA	
4	CF0585	HVABC Anti bird caging Grip, 95mm ²	2	EA	
5	CJ0461	Conductor Crimping ferrule 7/4.75	1	EA	
6	FJ0610	HVABC Cable Joint, 95-185mm ² XLPE	3	EA	

HA8_WIJ_185		HVABV Wood Pole Inline Joint_185mm ²			
ITEM NUMBER	STOCK CODE	DESCRIPTION	QTY ROD	UNIT OF MEASURE	REMARKS
1	AB6025	Eyebolt M16 x 450mm with Washers	2	EA	
2	CT0011	Clevis Thimble, Cond. 7/2.50-19/3.25	2	EA	
3	CF0580	Deadend Grip, Helically Cond. 19/3.65	2	EA	
4	CF0586	HVABC Anti bird caging Grip, 185mm ²	2	EA	
5	CJ0595	Conductor Crimping ferrule 19/3.75	1	EA	
6	FJ0610	HVABC Cable Joint, 95-185mm ² XLPE	3	EA	

HA8_CIJ_95		HVABV Concrete Pole Inline Joint_95mm ²			
ITEM NUMBER	STOCK CODE	DESCRIPTION	QTY ROD	UNIT OF MEASURE	REMARKS
1	CB3060	Metal Retaining Strap 50mm x 1.3m	2	EA	
2	CT0011	Clevis Thimble, Cond. 7/2.50-19/3.25	2	EA	
3	CF0757	Deadend Grip, Helically Cond. 7/4.75	2	EA	
4	CF0585	HVABC Anti bird caging Grip, 95mm ²	2	EA	
5	CJ0461	Conductor Crimping ferrule 7/4.75	1	EA	
6	FJ0610	HVABC Cable Joint, 95-185mm ² XLPE	3	EA	

HA8_CIJ_185		HVABV Concrete Pole Inline Joint_185mm ²			
ITEM NUMBER	STOCK CODE	DESCRIPTION	QTY ROD	UNIT OF MEASURE	REMARKS
1	CB3060	Metal Retaining Strap 50mm x 1.3m	2	EA	
2	CT0011	Clevis Thimble, Cond. 7/2.50-19/3.25	2	EA	
3	CF0580	Deadend Grip, Helically Cond. 19/3.65	2	EA	
4	CF0586	HVABC Anti bird caging Grip, 185mm ²	2	EA	
5	CJ0595	Conductor Crimping ferrule 19/3.75	1	EA	
6	FJ0610	HVABC Cable Joint, 95-185mm ² XLPE	3	EA	

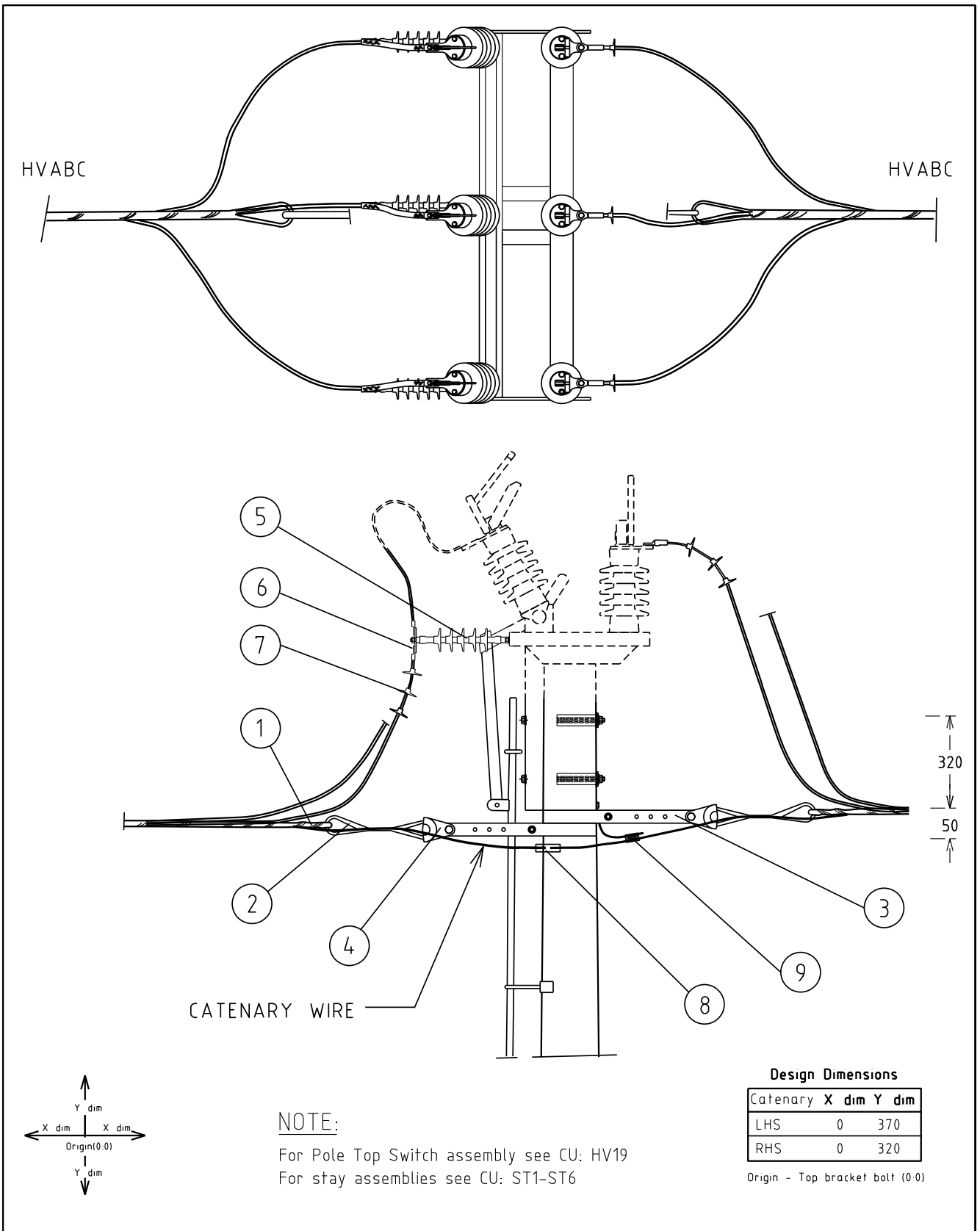

CATENARY WIRE

Design Dimensions

Catenary	X dim	Y dim
LHS	0	370
RHS	0	320

Origin - Top bracket bolt (0,0)

NOTE:

For Pole Top Switch assembly see CU: HV19
 For stay assemblies see CU: ST1-ST6

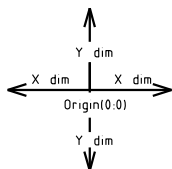

 DISTRIBUTION DESIGN CATALOGUE	COMPATIBLE UNIT	REV B	DATE: 12 04 2013
	POLE TOP SWITCH	DRAWING No. HA9	

CU		CU Description			
HA9_WPTS_95		HVABC Wood Pole PTS_95mm ² _22kV			
ITEM NUMBER	STOCK CODE	DESCRIPTION	QTY ROD	UNIT OF MEASURE	REMARKS
1	CF0585	HVABC Anti bird caging Grip, 95mm ²	2	EA	
2	CF0757	Deadend Grip, Helically Cond. 7/4.75	2	EA	
3	CB3060	Metal Retaining Strap 50mm x 1.3m	2	EA	
4	CT0011	Clevis Thimble, Cond. 7/2.50-19/3.25	2	EA	
5	GA4002	Surge Arrester 22kV, 10kA	3	EA	
6	GF1592	Copper Bus Conductor plate	3	EA	
7	FJ0189	HVABC Term Kit 95-185mm ² 3x1 Core	2	EA	
8	CJ0461	Conductor Crimping ferrule 7/4.75	1	EA	
9	CC0138	PG Clamp, Al, 7/2.50-19/3.25	1	EA	

HA9_WPTS185		HVABC Wood Pole PTS_185mm ² _22kV			
ITEM NUMBER	STOCK CODE	DESCRIPTION	QTY ROD	UNIT OF MEASURE	REMARKS
1	CF0586	HVABC Anti bird caging Grip, 185mm ²	2	EA	
2	CF0580	Deadend Grip, Helically Cond. 19/3.65	2	EA	
3	CB3060	Metal Retaining Strap 50mm x 1.3m	2	EA	
4	CT0011	Clevis Thimble, Cond. 7/2.50-19/3.25	2	EA	
5	GA4002	Surge Arrester 22kV, 10kA	3	EA	
6	GF1592	Copper Bus Conductor plate	3	EA	
7	FJ0189	HVABC Term Kit 95-185mm ² 3x1 Core	2	EA	
8	CJ0595	Conductor Crimping ferrule 19/3.75	1	EA	
9	CC0138	PG Clamp, Al, 7/2.50-19/3.25	1	EA	

HA9_CPTS_95		HVABC Concrete Pole PTS_95mm ² _22kV			
ITEM NUMBER	STOCK CODE	DESCRIPTION	QTY ROD	UNIT OF MEASURE	REMARKS
1	CF0585	HVABC Anti bird caging Grip, 95mm ²	2	EA	
2	CF0757	Deadend Grip, Helically Cond. 7/4.75	2	EA	
3	CB3060	Metal Retaining Strap 50mm x 1.3m	2	EA	
4	CT0011	Clevis Thimble, Cond. 7/2.50-19/3.25	2	EA	
5	GA4002	Surge Arrester 22kV, 10kA	3	EA	
6	GF1592	Copper Bus Conductor plate	3	EA	
7	FJ0189	HVABC Term Kit 95-185mm ² 3x1 Core	2	EA	
8	CJ0461	Conductor Crimping ferrule 7/4.75	1	EA	
9	CC0138	PG Clamp, Al, 7/2.50-19/3.25	1	EA	

CU	CU Description
----	----------------

HA9_CPTS185		HVABC Concrete Pole PTS_185mm ² _22kV			
ITEM NUMBER	STOCK CODE	DESCRIPTION	QTY ROD	UNIT OF MEASURE	REMARKS
1	CF0586	HVABC Anti bird caging Grip, 185mm ²	2	EA	
2	CF0580	Deadend Grip, Helically Cond. 19/3.65	2	EA	
3	CB3060	Metal Retaining Strap 50mm x 1.3m	2	EA	
4	CT0011	Clevis Thimble, Cond. 7/2.50-19/3.25	2	EA	
5	GA4002	Surge Arrester 22kV, 10kA	3	EA	
6	GF1592	Copper Bus Conductor plate	3	EA	
7	FJ0189	HVABC Term Kit 95-185mm ² 3x1 Core	2	EA	
8	CJ0595	Conductor Crimping ferrule 19/3.75	1	EA	
9	CC0138	PG Clamp, Al, 7/2.50-19/3.25	1	EA	

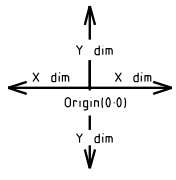
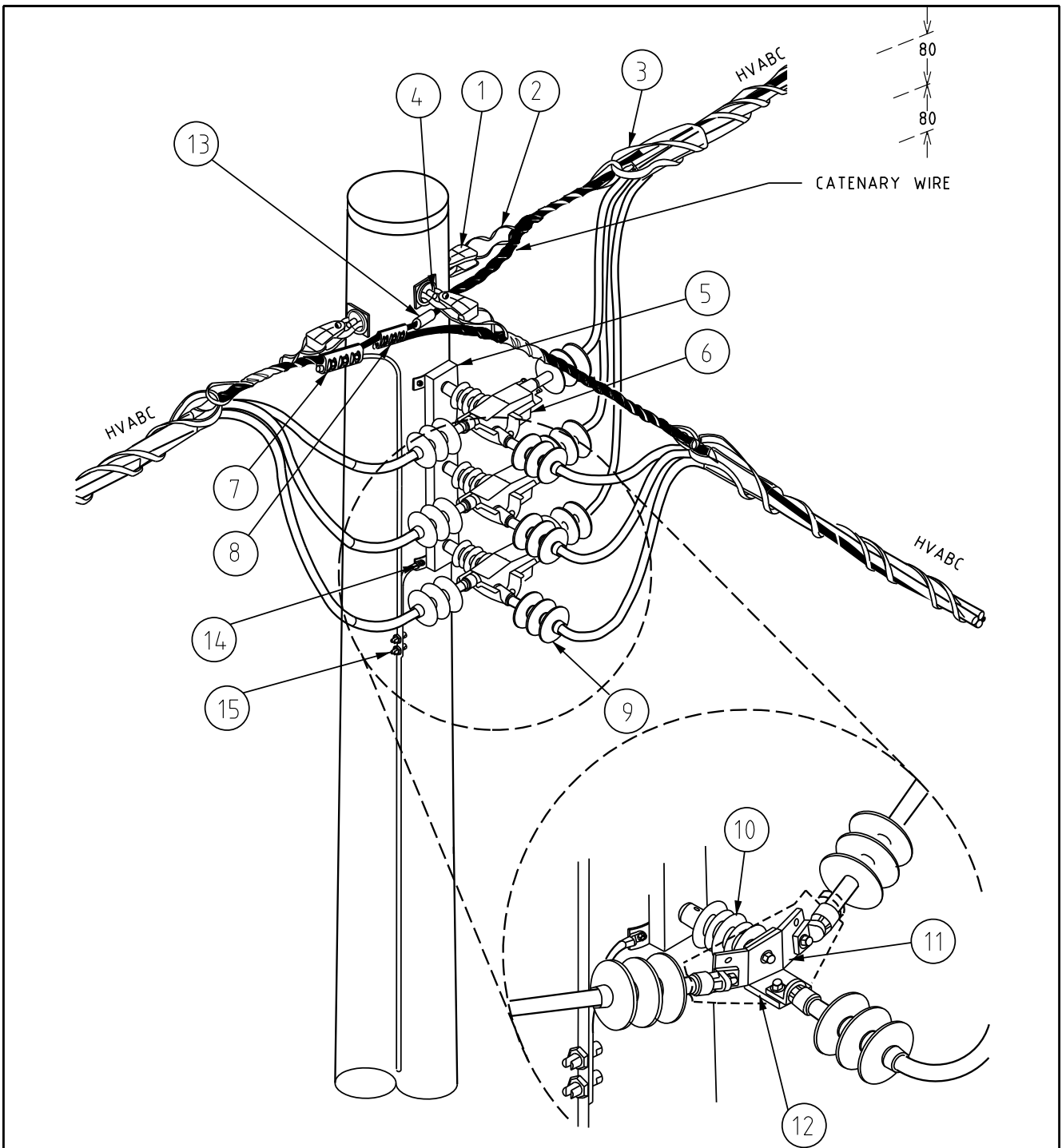

NOTE:

For stay assemblies see CU: ST1 - ST6
 For earthing assembly see CU: HV34

Design Dimensions

Catenary	X dim	Y dim
LHS	0	80
RHS	0	160
Front	0	0

Origin - Top bolt (0-0)

<p>DISTRIBUTION DESIGN CATALOGUE</p>	COMPATIBLE UNIT	REV B	DATE 12.04.2013
	HVABC TEE-OFF	DRAWING No HA10	

CU		CU Description			
HA10_WTO_95		HVABC Wood Pole Tee Off_95mm ²			
ITEM NUMBER	STOCK CODE	DESCRIPTION	QTY RQD	UNIT OF MEASURE	REMARKS
1	CT0011	Clevis Thimble, Cond. 7/2.50-19/3.25	3	EA	
2	CF0757	Deadend Grip, Helically Cond. 7/4.75	3	EA	
3	CF0585	HVABC Anti bird caging Grip, 95mm ²	3	EA	
4	AB6025	Eyebolt M16 x 450mm with Washers	3	EA	
5	CB3044	Insulator Mtg Bracket	1	EA	
6		Connection cover (Animal Protection)	3	EA	
7	CC0120	PG Clamp, Bi-Metal, 35-185mm ²	1	EA	
8	CC0138	PG Clamp, Al, 7/2.50-19/3.25	1	EA	
9	FJ0189	HVABC Term Kit 95-185mm ² 3x1 Core	3	EA	
10	GA4002	Surge Arrester 22kV, 10kA	3	EA	
11	GF1591	Copper Bus Conductor plate	3	EA	
12	GF1593	Copper Bus Conductor plate, T-Off	3	EA	
13	CJ0461	Conductor Crimping ferrule 7/4.75	1	EA	
14	FL0143	Eye Lug 19/1.83-19/2.11 Cable Size	1	EA	
15	FC0163	Split Bolt Max 95mm ² Type D	1	EA	

HA10_WTO_185		HVABC Wood Pole Tee Off_185mm ²			
ITEM NUMBER	STOCK CODE	DESCRIPTION	QTY RQD	UNIT OF MEASURE	REMARKS
1	CT0011	Clevis Thimble, Cond. 7/2.50-19/3.25	3	EA	
2	CF0580	Deadend Grip, Helically Cond. 19/3.65	3	EA	
3	CF0586	HVABC Anti bird caging Grip, 185mm ²	3	EA	
4	AB6025	Eyebolt M16 x 450mm with Washers	3	EA	
5	CB3044	Insulator Mtg Bracket	1	EA	
6		Connection cover (Animal Protection)	3	EA	
7	CC0120	PG Clamp, Bi-Metal, 35-185mm ²	1	EA	
8	CC0138	PG Clamp, Al, 7/2.50-19/3.25	1	EA	
9	FJ0189	HVABC Term Kit 95-185mm ² 3x1 Core	3	EA	
10	GA4002	Surge Arrester 22kV, 10kA	3	EA	
11	GF1591	Copper Bus Conductor plate	3	EA	
12	GF1593	Copper Bus Conductor plate, T-Off	3	EA	
13	CJ0595	Conductor Crimping ferrule 19/3.75	1	EA	
14	FL0143	Eye Lug 19/1.83-19/2.11 Cable Size	1	EA	
15	FC0163	Split Bolt Max 95mm ² Type D	1	EA	

CU	CU Description
----	----------------

HA10_CTO_95		HVABC Concrete Pole Tee Off_95mm ²			
ITEM NUMBER	STOCK CODE	DESCRIPTION	QTY ROD	UNIT OF MEASURE	REMARKS
1	CT0011	Clevis Thimble, Cond. 7/2.50-19/3.25	3	EA	
2	CF0757	Deadend Grip, Helically Cond. 7/4.75	3	EA	
3	CF0585	HVABC Anti bird caging Grip, 95mm ²	3	EA	
4	CB3060	Metal Retaining Strap 50mm x 1.3m	3	EA	
5	CB3044	Insulator Mtg Bracket	1	EA	
6		Connection cover (Animal Protection)	3	EA	
7	CC0120	PG Clamp, Bi-Metal, 35-185mm ²	1	EA	
8	CC0138	PG Clamp, Al, 7/2.50-19/3.25	1	EA	
9	FJ0189	HVABC Term Kit 95-185mm ² 3x1 Core	3	EA	
10	GA4002	Surge Arrester 22kV, 10kA	3	EA	
11	GF1591	Copper Bus Conductor plate	3	EA	
12	GF1593	Copper Bus Conductor plate, T-Off	3	EA	
13	CJ0461	Conductor Crimping ferrule 7/4.75	1	EA	
14	FL0143	Eye Lug 19/1.83-19/2.11 Cable Size	1	EA	
15	FC0163	Split Bolt Max 95mm ² Type D	1	EA	

HA10_CTO_185		HVABC Concrete Pole Tee Off_185mm ²			
ITEM NUMBER	STOCK CODE	DESCRIPTION	QTY ROD	UNIT OF MEASURE	REMARKS
1	CT0011	Clevis Thimble, Cond. 7/2.50-19/3.25	3	EA	
2	CF0580	Deadend Grip, Helically Cond. 19/3.65	3	EA	
3	CF0586	HVABC Anti bird caging Grip, 185mm ²	3	EA	
4	CB3060	Metal Retaining Strap 50mm x 1.3m	3	EA	
5	CB3044	Insulator Mtg Bracket	1	EA	
6		Connection cover (Animal Protection)	3	EA	
7	CC0120	PG Clamp, Bi-Metal, 35-185mm ²	1	EA	
8	CC0138	PG Clamp, Al, 7/2.50-19/3.25	1	EA	
9	FJ0189	HVABC Term Kit 95-185mm ² 3x1 Core	3	EA	
10	GA4002	Surge Arrester 22kV, 10kA	3	EA	
11	GF1591	Copper Bus Conductor plate	3	EA	
12	GF1593	Copper Bus Conductor plate, T-Off	3	EA	
13	CJ0595	Conductor Crimping ferrule 19/3.75	1	EA	
14	FL0143	Eye Lug 19/1.83-19/2.11 Cable Size	1	EA	
15	FC0163	Split Bolt Max 95mm ² Type D	1	EA	

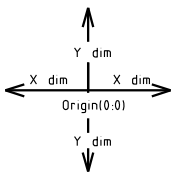
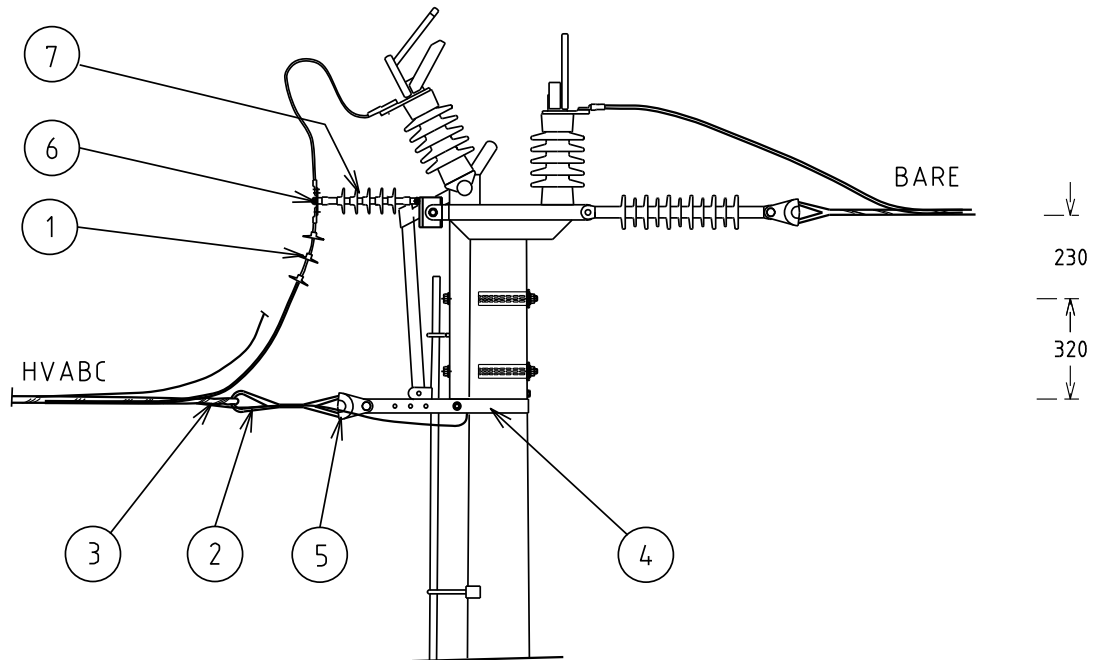
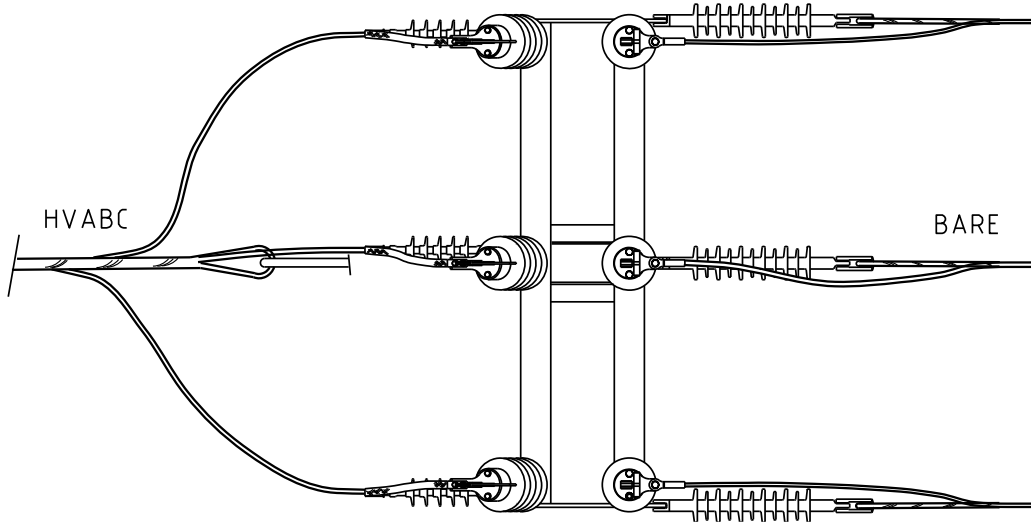

NOTE:

For Pole Top Switch assembly see CU: HV19
 For earthing assembly see CU: HV34
 For stay assemblies see CU: ST1-ST6

Design Dimensions

Catenary	X dim	Y dim
LHS	0	320
RHS	0	230

Origin - Top PTS bracket bolt (0:0)



DISTRIBUTION DESIGN
CATALOGUE

COMPATIBLE UNIT

POLE TOP SWITCH
HVABC - BARE

REV

B

DATE:

12 04 2013

DRAWING No

HA11



CU	CU Description
----	----------------

HA11_WAB_95		HVABC Wood Pole PTS ABC to Bare_95mm ²			
ITEM NUMBER	STOCK CODE	DESCRIPTION	QTY ROD	UNIT OF MEASURE	REMARKS
1	FJ0189	HVABC Term Kit 95-185mm ² 3x1 Core	1	EA	
2	CF0757	Deadend Grip, Helically Cond. 7/4.75	1	EA	
3	CF0585	HVABC Anti bird caging Grip, 95mm ²	1	EA	
4	CB3060	Metal Retaining Strap 50mm x 1.3m	1	EA	
5	CT0011	Clevis Thimble, Cond. 7/2.50-19/3.25	1	EA	
6	GF1592	Copper Bus Conductor plate	3	EA	
7	GA4002	Surge Arrester 22kV, 10kA	3	EA	

HA11_WAB_185		HVABC Wood Pole PTS ABC to Bare_185mm ²			
ITEM NUMBER	STOCK CODE	DESCRIPTION	QTY ROD	UNIT OF MEASURE	REMARKS
1	FJ0189	HVABC Term Kit 95-185mm ² 3x1 Core	1	EA	
2	CF0580	Deadend Grip, Helically Cond. 19/3.65	1	EA	
3	CF0586	HVABC Anti bird caging Grip, 185mm ²	1	EA	
4	CB3060	Metal Retaining Strap 50mm x 1.3m	1	EA	
5	CT0011	Clevis Thimble, Cond. 7/2.50-19/3.25	1	EA	
6	GF1592	Copper Bus Conductor plate	3	EA	
7	GA4002	Surge Arrester 22kV, 10kA	3	EA	

HA11_CAB_95		HVABC Concrete Pole PTS ABC to Bare_95mm ²			
ITEM NUMBER	STOCK CODE	DESCRIPTION	QTY ROD	UNIT OF MEASURE	REMARKS
1	FJ0189	HVABC Term Kit 95-185mm ² 3x1 Core	1	EA	
2	CF0757	Deadend Grip, Helically Cond. 7/4.75	1	EA	
3	CF0585	HVABC Anti bird caging Grip, 95mm ²	1	EA	
4	CB3060	Metal Retaining Strap 50mm x 1.3m	1	EA	
5	CT0011	Clevis Thimble, Cond. 7/2.50-19/3.25	1	EA	
6	GF1592	Copper Bus Conductor plate	3	EA	
7	GA4002	Surge Arrester 22kV, 10kA	3	EA	

HA11_CAB_185		HVABC Concrete pole PTS ABC to Bare_185mm ²			
ITEM NUMBER	STOCK CODE	DESCRIPTION	QTY ROD	UNIT OF MEASURE	REMARKS
1	FJ0189	HVABC Term Kit 95-185mm ² 3x1 Core	1	EA	
2	CF0580	Deadend Grip, Helically Cond. 19/3.65	1	EA	
3	CF0586	HVABC Anti bird caging Grip, 185mm ²	1	EA	
4	CB3060	Metal Retaining Strap 50mm x 1.3m	1	EA	
5	CT0011	Clevis Thimble, Cond. 7/2.50-19/3.25	1	EA	
6	GF1592	Copper Bus Conductor plate	3	EA	
7	GA4002	Surge Arrester 22kV, 10kA	3	EA	

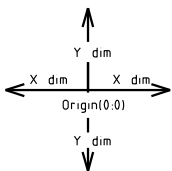
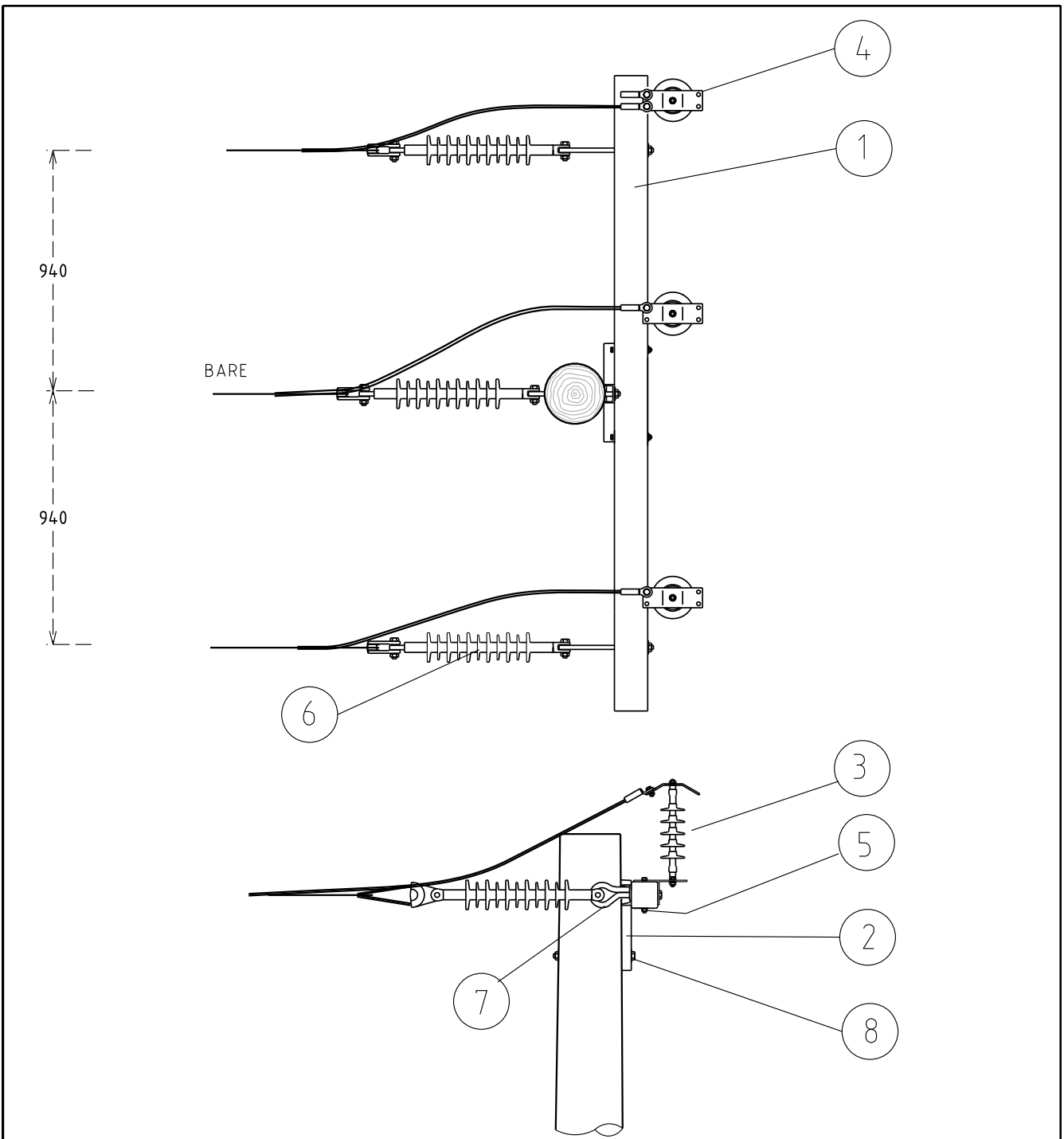

NOTE:

For earthing assembly see CU HV34
 For stay assemblies see CU-ST1-ST6

Design Dimensions

	X dim	Y dim
Left	940	0
Centre	0	0
Right	940	0

Origin - King bolt (0,0)

 DISTRIBUTION DESIGN CATALOGUE	COMPATIBLE UNIT	REV: B	DATE: 15 04 2013
	BARE TERMINATION ON SURGE ARRESTERS		DRAWING No: HA12

CU	CU Description
----	----------------

HA12_WBT_95		HVABC Wood Pole Bare Termination on Surge Arresters_95mm ²			
ITEM NUMBER	STOCK CODE	DESCRIPTION	QTY ROD	UNIT OF MEASURE	REMARKS
1	CB1121	Crossarm,Metal 2.4m Long	1	EA	
2	CB3025	HV Crossarm T-Bracket	1	EA	
3	GA4002	Surge Arrester 22kV, 10kA	3	EA	
4	GF1591	Copper Bus Conductor plate	3	EA	
5	CZ0366	Crossarm Bolt 130mm Long Steel,Galv	3	EA	
6	IC0018	Strain Insulator	3	EA	
7	AB6025	Eyebolt M16 x 450mm with Washers	3	EA	

HA12_WBT_185		HVABC Wood Pole Bare Termination on Surge Arresters_185mm ²			
ITEM NUMBER	STOCK CODE	DESCRIPTION	QTY ROD	UNIT OF MEASURE	REMARKS
1	CB1121	Crossarm,Metal 2.4m Long	1	EA	
2	CB3025	HV Crossarm T-Bracket	1	EA	
3	GA4002	Surge Arrester 22kV, 10kA	3	EA	
4	GF1591	Copper Bus Conductor plate	3	EA	
5	CZ0366	Crossarm Bolt 130mm Long Steel,Galv	3	EA	
6	IC0018	Strain Insulator	3	EA	
7	AB6025	Eyebolt M16 x 450mm with Washers	4	EA	

HA12_CBT_95		HVABC Concrete pole Bare Termination on Surge Arresters_95mm ²			
ITEM NUMBER	STOCK CODE	DESCRIPTION	QTY ROD	UNIT OF MEASURE	REMARKS
1	CB1121	Crossarm,Metal 2.4m Long	1	EA	
2	CB3051	Crossarm Mtg Bracket, Concrete Pole	1	EA	
3	GA4002	Surge Arrester 22kV, 10kA	3	EA	
4	GF1591	Copper Bus Conductor plate	3	EA	
5	CZ0366	Crossarm Bolt 130mm Long Steel,Galv	3	EA	
6	IC0018	Strain Insulator	3	EA	
7	AB6025	Eyebolt M16 x 450mm with Washers	3	EA	
8	CB7541	U-Bolt Concrete Pole strap, M16	2	EA	

CU	CU Description
----	----------------

HA12_CBT_185		HVABC Concrete Pole Bare Termination on Surge Arresters_185mm ²			
ITEM NUMBER	STOCK CODE	DESCRIPTION	QTY RQD	UNIT OF MEASURE	REMARKS
1	CB1121	Crossarm,Metal 2.4m Long	1	EA	
2	CB3051	Crossarm Mtg Bracket, Concrete Pole	1	EA	
3	GA4002	Surge Arrester 22kV, 10kA	3	EA	
4	GF1591	Copper Bus Conductor plate	3	EA	
5	CZ0366	Crossarm Bolt 130mm Long Steel,Galv	3	EA	
6	IC0018	Strain Insulator	3	EA	
7	AB6025	Eyebolt M16 x 450mm with Washers	3	EA	
8	CB7541	U-Bolt Concrete Pole strap, M16	2	EA	